

Highland

A U D I O

SEIS PACK



Thanks to its compact dimensions and its appealing look, you can position Seis 1201 speakers anywhere, without disfiguring your decor. The luxury piano black lacquer finish will surely please artwork addicts. With its small footprint, Seis 1201, smartly mounted on HiStand or hung on the wall, feels right at home in even the smallest bedroom. Seis 1201 is so tiny and affordable, that it becomes possible to create stereo or multichannel systems everywhere.

Details



Piano black lacquer



Black

Packaging

Pack 5.1 (Seis 1201 x 4; Seis 120C x 1;

Dord 165 x 1):

W23" x H11.25" x D24"

W584 x H286 x D614 mm

Pack 2.0 (Seis 1201 x 2):

W11" x H10.55" x D9"

W279 x H268 x D231 mm

Packaging: Cardboard

4 printed sides packaging

Weight

By pack: Net = 42 lbs / 19 kg ;

Gross = 47.4 lbs / 21,5 kg

Specifications

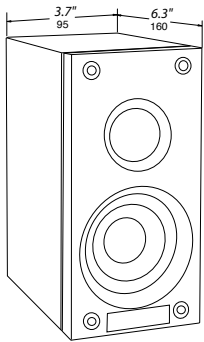

SEIS 120I

Type: bass-reflex 2 ways

Enclosure: bass-reflex
Recommended amplifier: 5 - 15 W

Mid-bass driver: 3" (7,6 cm) ceramic on metal
Tweeter: 1" (2,5 cm) titanium dome, neodymium magnet

Frequency response: 80 Hz - 20 kHz
Sensitivity: 84 dB/1 W/1 m
Impedance: 6 Ω
Crossover frequency: 3.5 kHz - 12 dB/octave

Terminal: gold plated
Magnetic shield: yes

Weight: Net: 7 lbs ; 3.2 kg
Gross: 9.9 lbs ; 4.5 kg

Dimensions with H7.5" x W3.7" x D7.5"
grill and terminals: H190 x W95 x D190 mm

Pack weight: Net: 62.1 lbs ; 28.3 kg / Gross: 81.4 lbs ; 37 kg

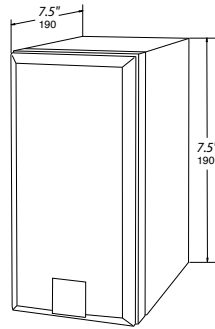

SEIS 120C

bass-reflex 2 ways

bass-reflex
5 - 30 W

2 x 3" (7.6 cm) ceramic on metal
1" (2.5 cm) titanium dome
neodymium magnet

80 Hz - 20 kHz
85 dB/1 W/1 m
4 Ω
3 kHz - 12 dB/octave

Bi-wiring gold plated
yes

Net: 12.1 lbs ; 5.5 kg
Gross: 15.4 lbs ; 7 kg

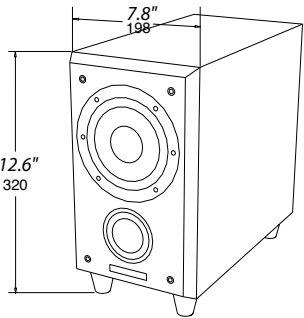
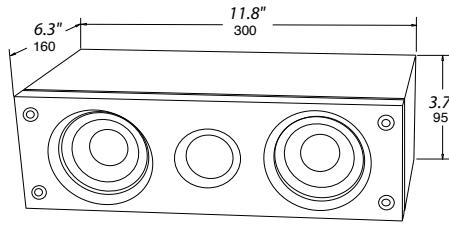

DORD 165

Active Subwoofer

bass-reflex
100 W - classe AB internal

6.5" (17 cm)

38 Hz - 150 Hz
filter : 40 Hz - 150 Hz
Level adjustable
Phase 0° / 180°

line and speaker level
Yes

Net: 22 lbs ; 10 kg
Gross: 26.4 lbs ; 12 kg

Response curves

Response curve:

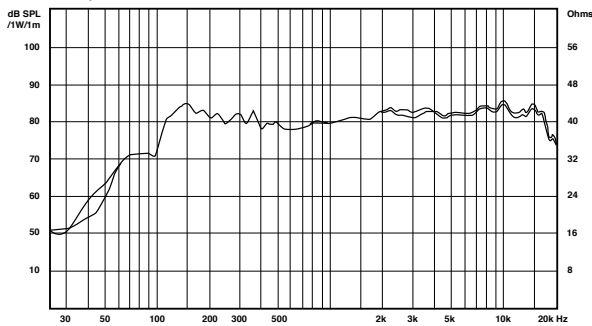

SEIS 120I

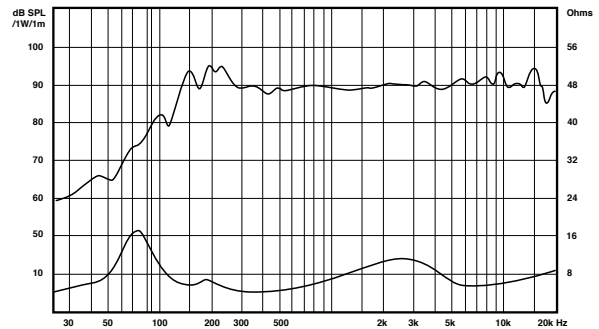

SEIS 120C

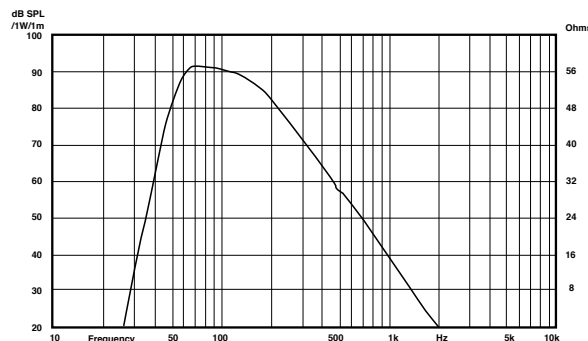

DORD 165